

Project / Model

23.007

40' Tyre Service Container

Explanation

40' HQ ISO Container

Info

Date : 23.01.2023

Rev. : 00.00.0000

Per. : Metin ALCAR

Tel. : 0544 242 04 91

Mail : sales@aluratrailer.com

A 01

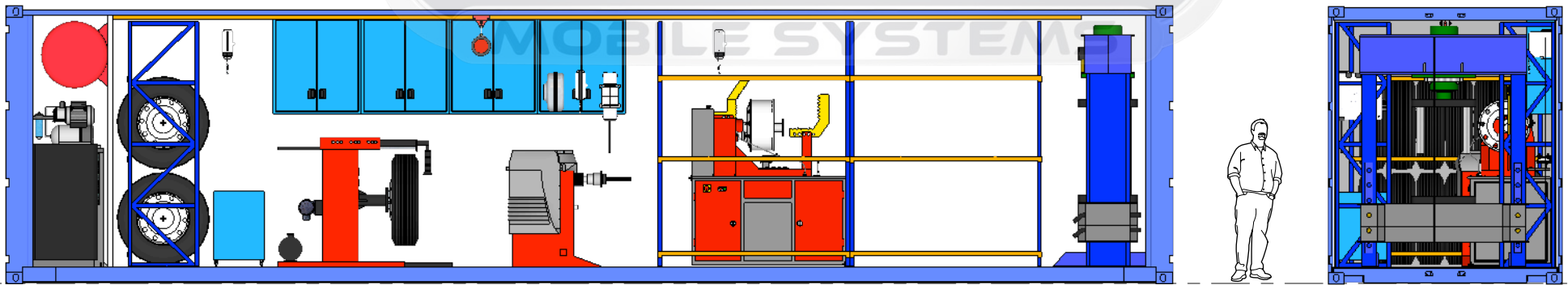
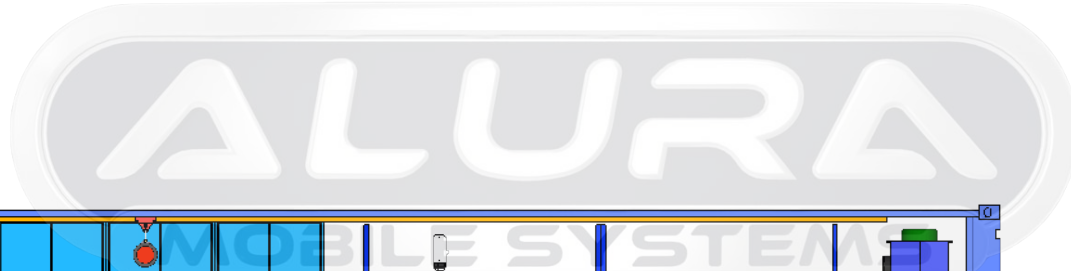
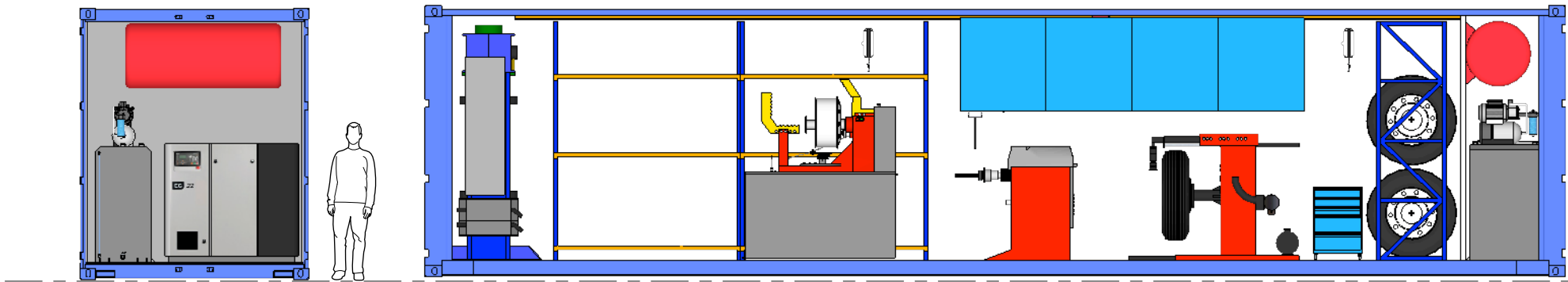

Project / Model
23.007
40' Tyre Service Container

Explanation
 40' HQ ISO Container

Info
 Date : 23.01.2023
 Rev. : 00.00.0000
 Per. : Metin ALCAR
 Tel : 0544 242 04 91
 Mail : sales@aluratrailer.com

A 02

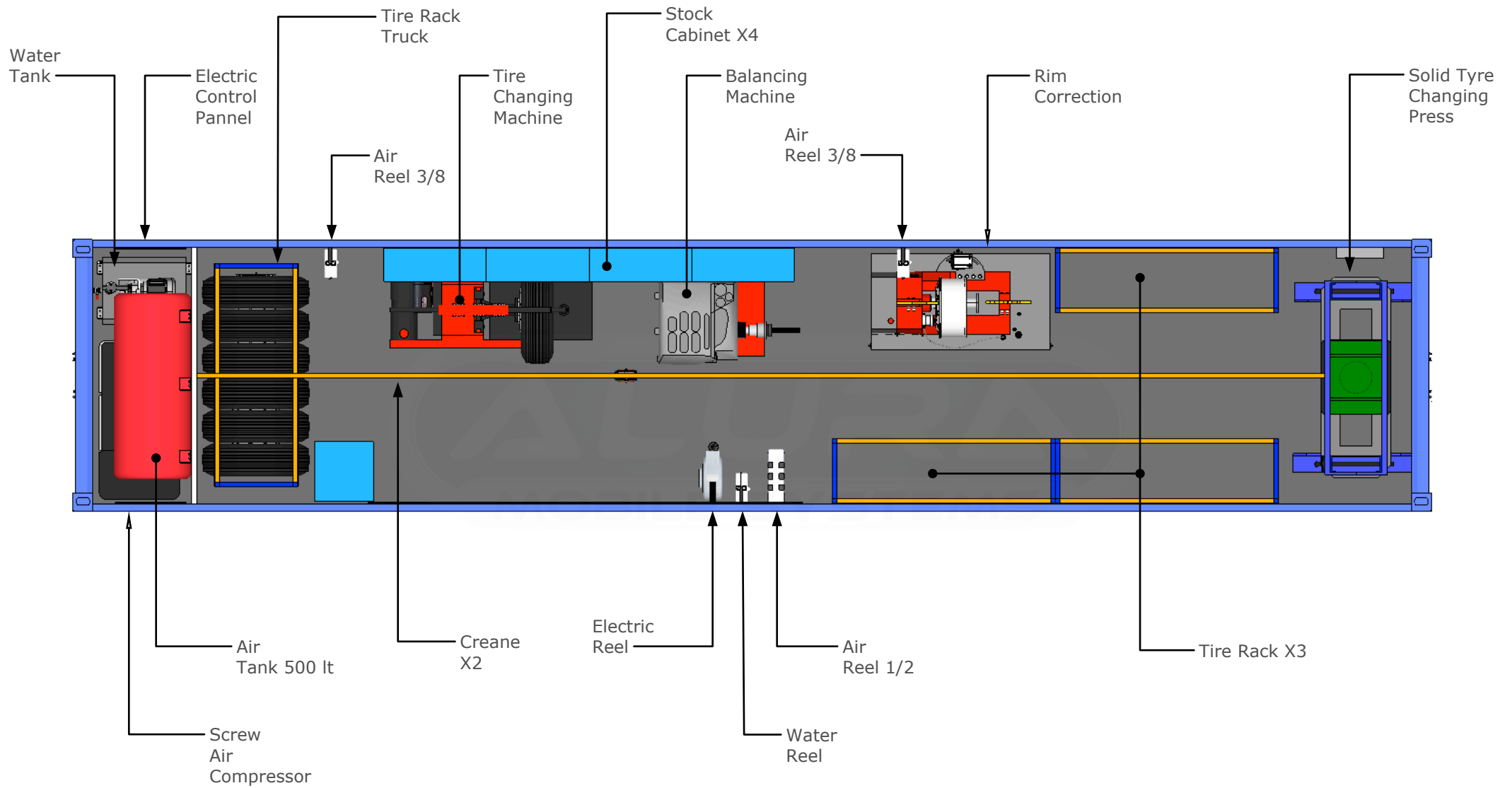

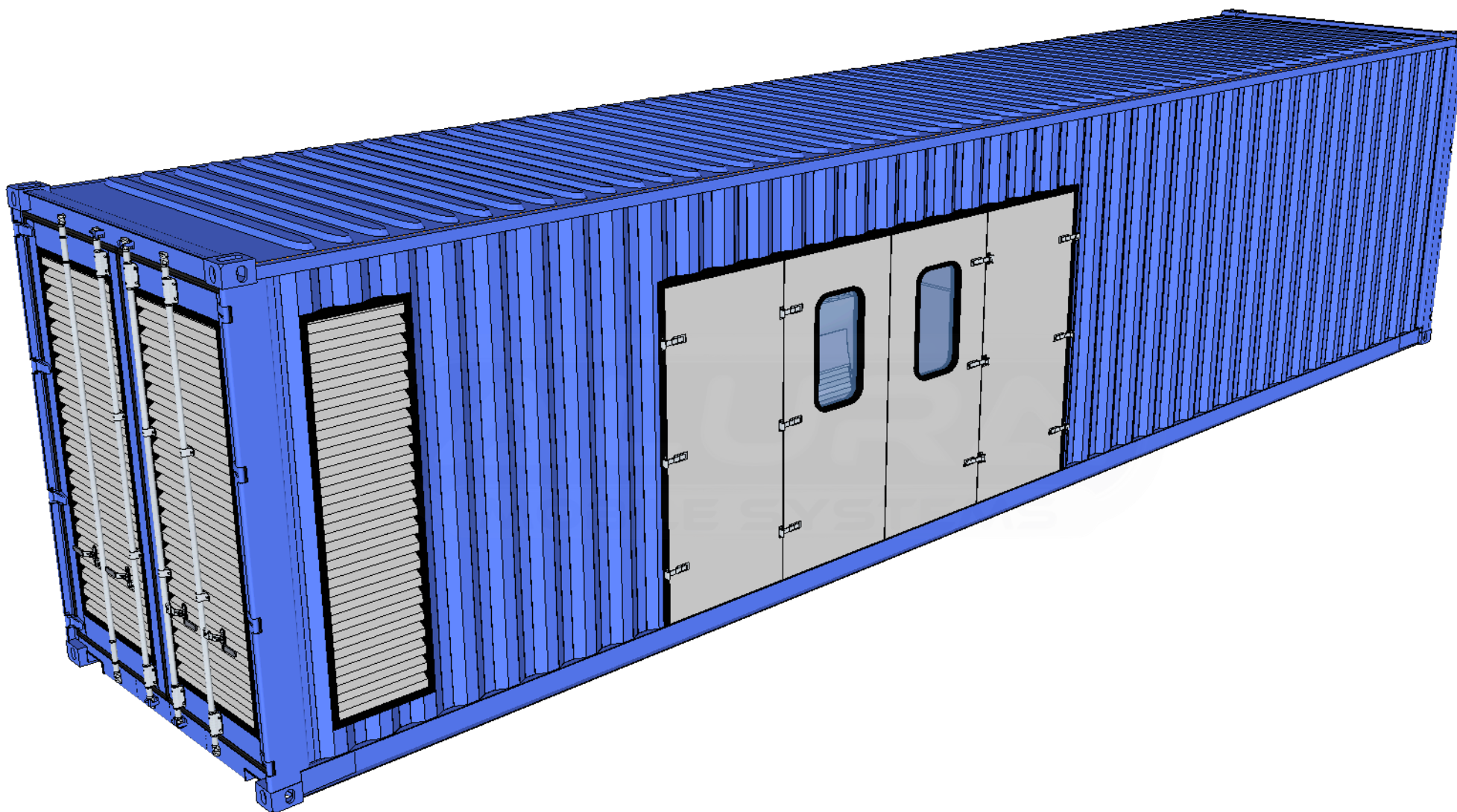

Project / Model

23.007

40' Tyre Service Container

Explanation

40' HQ ISO Container

Info

Date : 23.01.2023

Rev. : 00.00.0000

Per. : Metin ALCAR

Tel : 0544 242 04 91

Mail : sales@aluratrailer.com

A 04

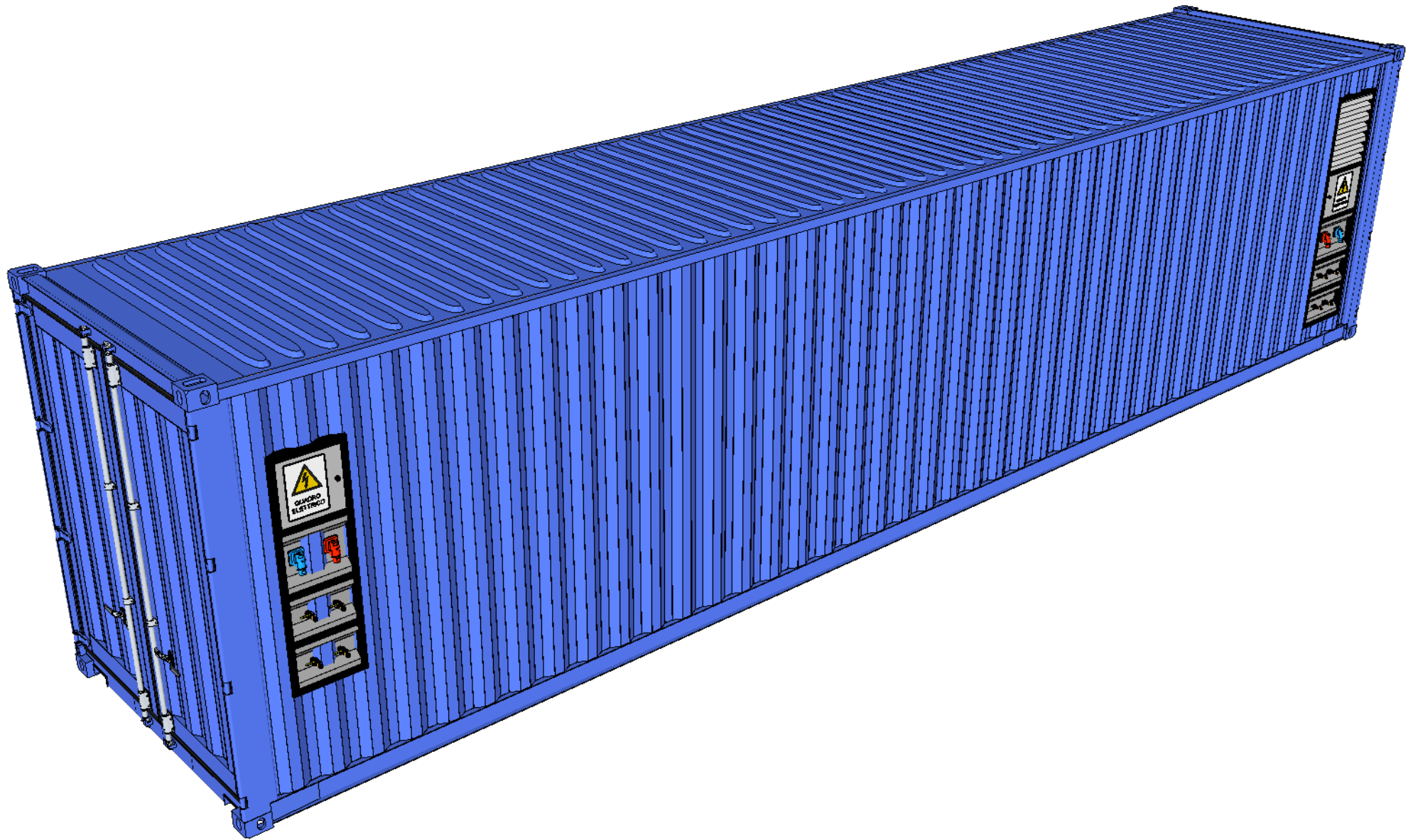

Project / Model
23.007
40' Tyre Service Container

Explanation
40' HQ ISO Container

Info
Date : 23.01.2023
Rev. : 00.00.0000
Per. : Metin ALCAR
Tel : 0544 242 04 91
Mail : sales@aluratrailer.com

A 05

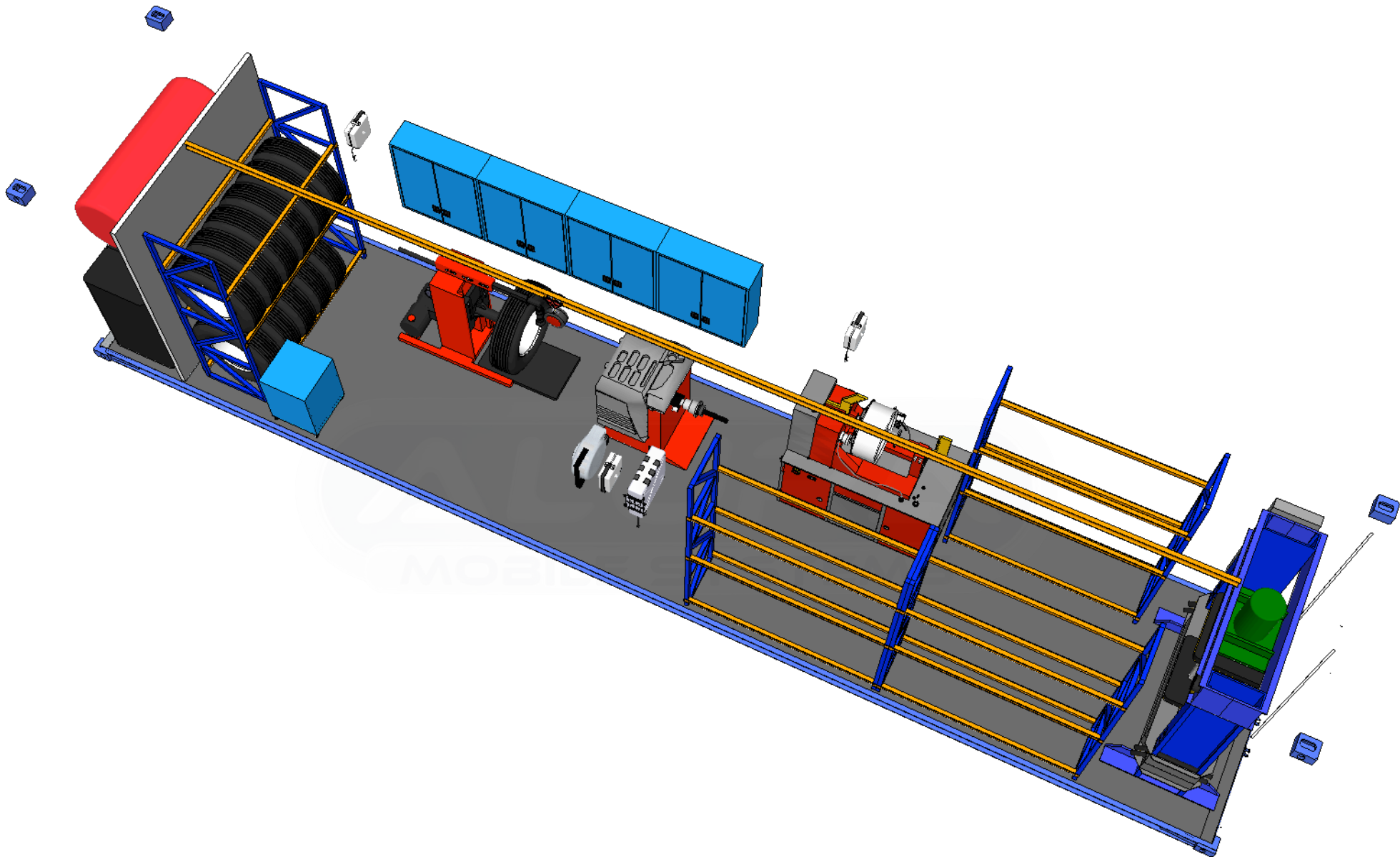

Project / Model
23.007
40' Tyre Service Container

Explanation
 40' HQ ISO Container

Info
 Date : 23.01.2023
 Rev. : 00.00.0000
 Per. : Metin ALCAR
 Tel : 0544 242 04 91
 Mail : sales@aluratrailer.com

A 06

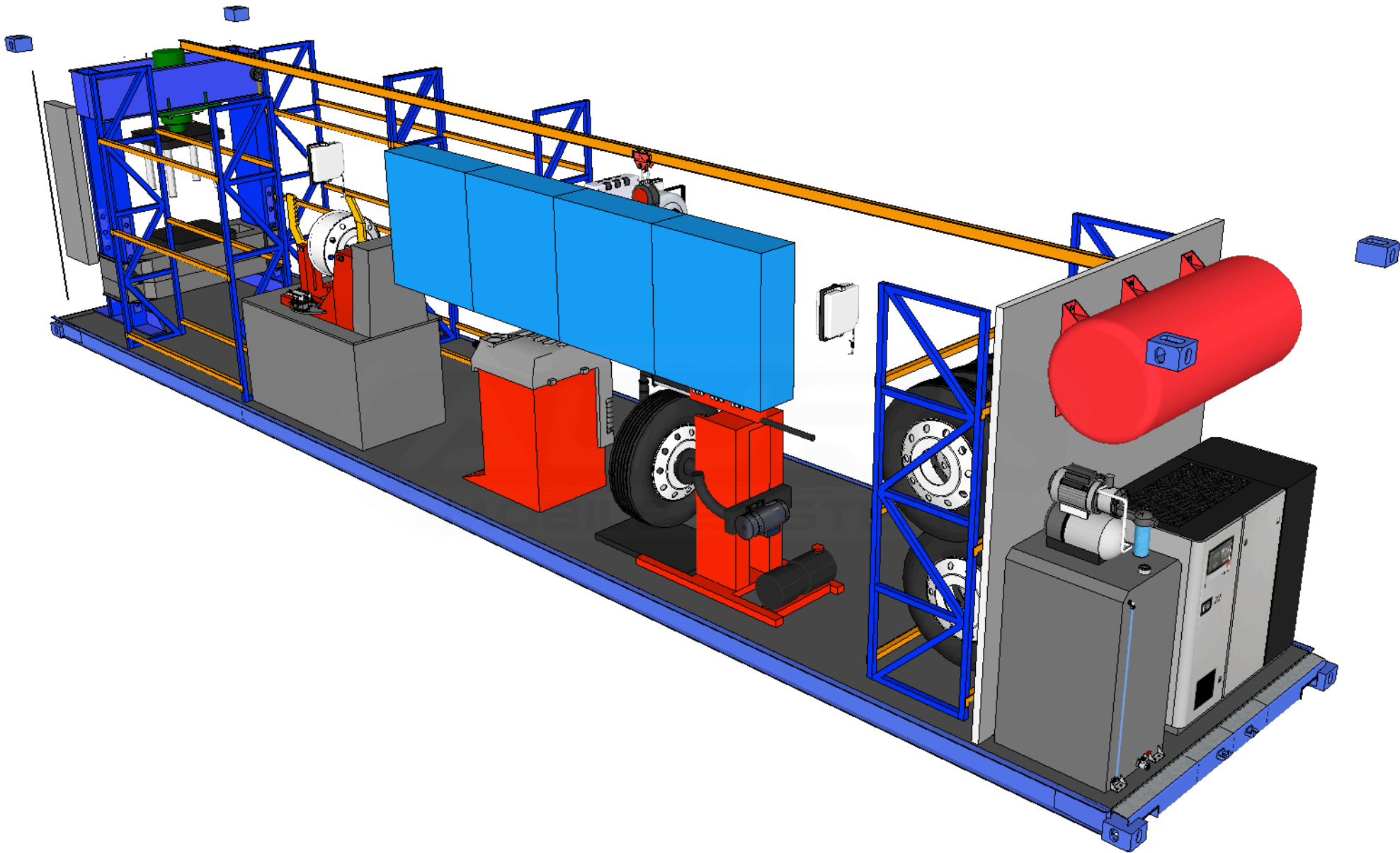

Project / Model

23.007

40' Tyre Service Container



Explanation





40' HQ ISO Container





Info





Date : 23.01.2023
 Rev. : 00.00.0000
 Per. : Metin ALCAR
 Tel : 0544 242 04 91
 Mail : sales@aluratrailer.com





A 07





No	Equipment	Explanation	Orjin	Piece
1		Bodywork 40' HQ / ISO Container External Dimensions Length: 12.192 mm Width: 2.432 mm Height: 2.896 mm Internal Dimensions Length: 12.024 mm Width: 2.350 mm Height: 2.697 mm Area : 76.2 m3 Tare: 4.020 kg. Insulation: Polyurethane 30 mm Inner coating: Alukobond 4 mm Floor: Polywood 18 mm Floor Covering: PVC 2,5 mm	Alura Turkey	1
2		Workbench Wheeled Drawer Width: 600 mm Depth: 465 mm Height: 950 mm Number of Drawers: 6 Pieces Drawer Transport Cap. : 60 kg.	Alura Turkey	1
3		Metal Cabinet Width: 1.000 mm Depth: 450 mm Height: 2000 mm Number of Shelves: 7 Pieces Shelf Carrying Cap .: 80 kg. Variable drawer groups Body and carriers 0.80 - 1.2 mm sheet metal It is long-lasting and durable. The covers are double wing reinforced.	Alura Turkey	1





No	Equipment	Explanation	Orjin	Piece
4		Tire Stock Rack Big Vehicle Tire Dimensions: 750 x 2.000 x 2.500mm Material: Metal Iron. Load: 3,000 kg Shelf Height: Adjustable. Capacity : About 6 + 6 : 12 Tires	Alura Turkey	1
5		Tire Stock Rack Minibus and Car Tire Dimensions: 550 x 2.000 x 2.500mm Material: Metal Iron. Load: 3,000 kg Shelf Height: Adjustable. Capacity: About 10 + 10 : 20 Tires	Alura Turkey	3
6		Screw Compressor Working Capacity: 10 bar. Capacity: 0.75-26,5 m3/min - cfm. Engine Power: 5.5 kW/hp. Volts: 400/3 w/p Length: 1450mm. Width: 750mm. Height: 1750mm. Connection: 3/4 inch.	Aykom Turkey	1
7		500 lt Air Tank	Aykom Turkey	1



No	Equipment	Explanation	Orjin	Piece
8		Tire Removal Rim Diameter : 14"-30" Tire Weight : 1000kg Max. Tire Width : 700x1600 Max. mm Single Speed Engine Standart Standart Rim Fixing Clamp and Lever Standart Remote Controller Optional Cable Controller Optional Moving Controlling Panel Product Dimensions : 105x102x145 cm. Net Weight : 542 Kg	Atek Turkey	1
9		Tire Balancing Machine For truck and bus tires Digital display Rim size: 8"-26" Rim width: max. : 8.5"-28" Tire size : 50" Max. tire weight : 200 kg. Easy, fast menu and graphics With tire lift	Atek Turkey	1
10		Rim Diameter: 10" / 24" Rim Type : Alloy/Sheet Metal Support Type : Bridged Turning Type : Sliding Motor Type : Geared Engine Rotation Speed : 98 Rpm Product Dimensions : 120x97x171 cm Net Weight : 370 Kg	Atek Turkey	1
11		Tyre Pres Static Press 200 ton 10" - 25" Tyre Attachment - Down stroke ram - Milled spider plate - 3 phase power packs Aperture Dimensions Bed width: 1.050 mm Aperture width: 1.200 mm Aperture height to spider: 1.000 mm Spider plate diameter: 915 mm	HDS Turkey	1

No	Equipment	Explanation	Orjin	Piece
12		Dismantling Tools 2 sets of removal / installation tools for 8" 1 set of removal / installation tool for 9" 1 set of removal / installation tool for 10" 1 set of removal / installation tool for 12" 1 set of removal / installation tool for 15" 1 set of removal / installation tool for 20" 1 set of removal / installation tool for 24" 1 set of removal / installation tool for 25"	HDS Turkey	1
13		Tire Removal Drive size : "25.4 Inch Capacity bolt size : 40.0 mm Torque range : 1,000-2,000 Nm. Weight (w / o socket) : 10,9 Kg. Length (w / o socket) : 285,0 mm. Free speed : 431.0 Rpm. Impact per min. : 4,300 lpm. Air consumption : 0.80 m3 / min Hose size : 12.7 mm.	Kuken Japan	1
14		Air Impact Wrench OPT 600: 1 pcs. Socket: 8 pcs. Socket : 3/4" 26-27-29-30-32-35-36-38.00 mm	Kuken Japan	1
15		Air Impact Wrench Length : 156 mm Stone Diameter : 32 mm Pen Diameter : 6 mm Idle Speed : 22,000 rpm Hose Diameter : 8 mm Air Inlet Nipple : 1/4 " Air Consumption : 300 lt / min Working Pressure : 90 psi (6.2 atu) Weight : 0,7 kg	Kuken Japan	1
16		Air Impact Wrench Tire Tyre Puncture Repair Kit Car	Raasm Italy	1

No	Equipment	Explanation	Orjin	Piece
17		Stainless Water Tank Metal Prisma Tank 2 mm / 500Lt.	Alura Turkey	1
18		Air Reel Pressure: 20 bar. Compatible fluids: Air Swivel joint: Stainless Metal Seals: Polyurethane Characteristic: Fixed Material: Painted steel Inlet: G 1/2 " (f) Outlet: G 1/2 "(f) Reel flow path: Zinc plated steel Internal drum width: 110 mm Single row steel wire braid with high tensile strength High resistance to oil and wear Operating temperature -40 C / +100 C Size: 1/2 " Pressure: 10 bar Length: 25 mt.	Raasm Italy	1
19		Air Reel Set Professional Blow Gun	Raasm Italy	1
20		Water Transfer Set Length hose : 11 mt. Length hose con. : 1,5 mt Hose diameter : 8x12 mt. Inlet connection thread : G 1/4" Max working pressure : 10 bar	Raasm Italy	1
21		Electric Reel 415 VAC 3 phase - 240 VAC 1 phase Auto Loopback Thermoplastic Cable 4 socket outlet 240 VAC 3 pcs 380 VAC 1 pcs	Raasm Italy	1

No	Equipment	Explanation	Orjin	Piece
22		Water Transfer Set Maximum Motor power : 1000 W Maximum Water Flow: 4500 l/hour Maximum pressure: 50/5 m/bar Working pattern: 1.9 - 3 bar Maximum suction : 8 m Connection type : G1 Power Cable H05RN-F : 1 m Weight without accessories : 14.7 kg	Karcher Garmany	1
23		Hydraulic & Pneumatic Jack Lifting Capacity: 15-30-45 tons Working Type: Hydro-Pneumatic Piston: 3 Pcs First Piston Cap. : 15 tons Second Piston Cap. : 30 tons Third Piston Cap. : 45 tons Minimum Height: 156 mm Max. Height: 327 mm Extension Socket: 497 mm Working Pressure: 8 bar Dimension: 350x850x1409 mm Net Weight: 85 kg.	Atek Turkey	1
24		Hydraulic Jack Capacity : 20 ton Max. Height : 230 mm Weight 11,5 kg Overall Size: 330 x 175 x 285 mm	Atek Turkey	1
25		Hydraulic Jack Capacity: 10 tons Model: Hydraulic Weight: 150 kg Length: 1700 mm Open height: 650 mm Width: 450 mm	Star Turkey	1
26		Jack Stand Capacity: 6 / 12 Ton. Lifting Height: 450 / 600 mm.	Atek Turkey	2

No	Equipment	Explanation	Orjin	Piece
27		Chain Crane Capacity 1.000 Kg. Chain 5 mt.	Atlas Kore	1
28		Lighting Body : Polycarbonate RAL 9003 body , Metal lock clip Diffuser: Polycarbonate opal cover Light Source: Mid Power LED Consumption Power: 28 W / 38 W / 55 W Input Voltage: 220-240V AC 50/60 Hz CRI: >80 IP Value: IP65 Usage: Surface Mounted	EAT Turkey	12
29		Control panel of all equipment. Generator / Mains power connection.	Alura Turkey	1
30		Fire extinguisher Capacity: 6 kg. Full Weight: 9.1 kg. Working Pressure: 18 bar. Discharge Time: 14 sec. Extinguishing Agent: MAP@ (ABC)	Cakir Turkey	2
31		Pressure Regulator Air Inlet: 1/2 inch Filter : 20U Working Pressure : 05-9.9 Atu Working temperature : 5-60 ° C Water Capacity : 80 MI Air Permeability : 2200Lt / Dk	Osaka Japan	1

No	Equipment	Explanation	Orjin	Piece
32		Compressed air line installation. Polyurethane Pneumatic fittings	Termofix Turkey	1
33		Compressed air line installation. Polyurethane Pneumatic hose 10 mm.	Airflex Turkey	1
34		Hand Tools Set Mechanical Tool Kit 43 Pieces	Cetaform Turkey	1